

# AIRENCE

*Transforms your idea's into reality*



P R O D U C T I O N | O N - A I R C O N S O L E

Unlimited numbers of inputs  
Split version design  
Budget friendly  
Program and Sub busses  
USB control section included

Ideal for production and On-AIR use  
Studio, Announcer and Phones outputs  
Bi directional Cue communication buss  
Two dedicated positions for Telco|VoIP|WPC  
Internal NON STOP switching

# DR

# Control Over Every Aspect of Radio

**W**ith the AIRENCE mixer you can now own a modern, split version type of radio mixer for a very attractive price. It's a carefully handmade piece of precision equipment and well build around proven low noise circuitry. It is an intelligent mixer with an internal USB control section that comfortably enhances daily use. It is a reliable workhorse for the self-op production D.J. it has built in Telco|VoIP or Wireless Phone Channels, 4 channels USB and 4 low noise Mic inputs. The AIRENCE stands for a very complete radio system, ideal for ON-AIR, Production and streaming to the web. The AIRENCE accepts and instantly controls a maximum 4 stereo channels from your Play-out software. It is built in a heavy duty RF shielded chassis, designed with elegantly rounded corners. And...“dropped” into your furniture it gives that exciting radio look. There is hardly no excuse that is keeping you from making radio you always wanted. Reliable, strong and the result of more than 52 years of experience at D&R.

## MIC, LINE, USB, Bluetooth and Hybrids.

The AIRENCE main unit has 4 balanced, phantom powered mic inputs with inserts for voice processors. Six stereo line inputs, 4x USB channels and 2x Telco|VoIP|WPC. Only one physical USB connection is the interface to transfer 4 stereo audio channels from and to your PC. Channel 5 and 6 have, apart from the stereo line input, also RJ-11 connectors to interface with an analog telephone line and a desk phone with dial unit. High quality built in Hybrids with direct access R and C balance and Talk back to the Hybrid channels make conversation with callers very easy. The Cue bus is also a communication buss, so the announcer can easily have a discussion with the caller outside the broadcast. Just hit the two related CUE buttons and you're talking. There is a very musical 3 band Equalizer on channel 1-4 and on all 6 Triple input channels of the Extender Unit. The stereo Aux send can be selected pre or post fader. And all high quality low noise mic inputs have low cut jumpers.

6 channel Extender

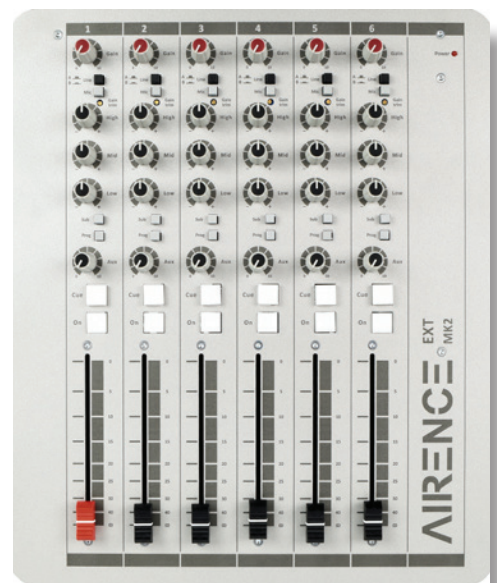

## EXTENSIVE MASTER SECTION DESIGNED WITH RADIO IN MIND.

The AIRENCE master section houses all the master controls such as 100 mm stereo master faders, stereo Aux send and return, monitor master with "follow phones" and a phones output with a split listen function. There is a balance control to continuously adjust the volume between main output and a stereo Cue signal. For logging your broadcast, there is a Record output that can be fed from the Main Program signal or the SUB bus signal or even the Aux output signal. In addition, there is a special Radio On-air/production section featuring; Mute by Mic switches to automatically cut control room level when the D.J. Mic is active. A Studio output that normally follows the main output can be routed in a way so any cue signal that is selected, can be heard when in the "follow phones" mode. Also here is Speaker Mute-Activation possible when Announcers use loudspeakers in the studio room. The Talk-back switch activates the built-in talkback microphone for communication to various outputs.

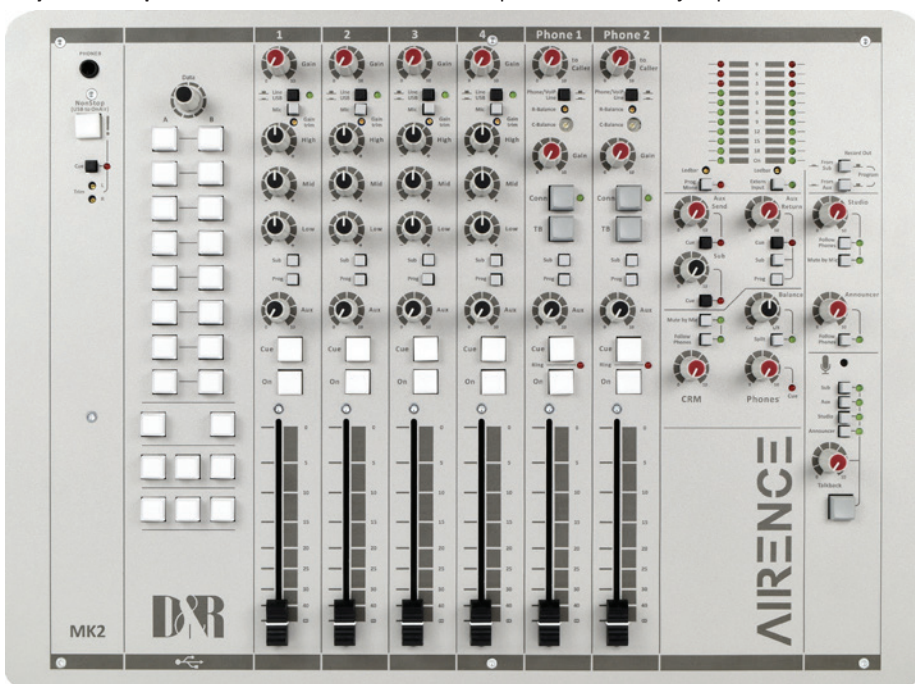

New 2024 model with control section left

# AIRENCE - USB

a Superb Broadcast Solution



Feels good does more

# You Want Flexibility? This is It!

You might have noticed that the channels have Sub and Program routing. It means that production (voice tracking) can be done on the SUB output while ON-AIR. The AIRENCE can also be used for production while ON-AIR when it is put into the NON-STOP mode. A single switch routes one of the 4 USB channels directly to the main outputs. A large grey Talkback switch completes the mastersection.

The AIRENCE is designed to be the focal point for local radio production work in the studio or... at home. Its understandable features makes it the ideal companion for rapid on-the-spot radio programs.

The AIRENCE is compact, reliable and ideal for production rooms. It can also double as an On-Air mixer or implemented as your own Internet Radio station. If your budget is tight start with the 6 channel version which is a complete system to begin with.

And it never becomes obsolete as it can be used as pre-production mixer, if, at a later date, you fit in a larger On-Air mixer. But... if more inputs are needed buy the AIRENCE-EXT(ender) and instantly you have 6 more triple inputs with each giving you a low noise Mic and 2x stereo line inputs under control.

The Cue buss is of course linked. Not enough? Buy another 6 channel unit to expand to 18 or even more Triple input channels.

Every system unit has its own very efficient, switched mode heavy duty power supply.

## USB CONTROL SECTION.

On the left side of the AIRENCE-MAIN mixer you see 24 illuminated (green/red or yellow) switches and one Encoder.

These switches can be used to control functions in your Radio Automation such as starting jingles and switching between live and NON-STOP. Software is downloadable from our wiki page.

Recording a voice track while ON-AIR is ofcourse possible. The USB control software, part of the package, can be easily programmed by yourself, to make radio even more exciting.

Any switch can perform a function of your play-out software when you think it would be convenient to control. As a feedback of the action the switches can light up green red or yellow.

Every unit is individually powered by a switched mode power supply. Power supply redundancy is an option with the optional extra power input connector. The control surfaces can be easily mounted inside furniture as a drop through unit with rounded off corners to make a nice fit with a script-space in the middle.

The front panel thickness is 2mm with a corner radius of 20mm.

Connection between Main unit and Extender unit is by way of a shielded Sub-D cable with a length of 1.8 meter.

All in and output connections are on standard Jack / Cinch and XLR connectors. Power supply input is a 5 pin XLR connector.

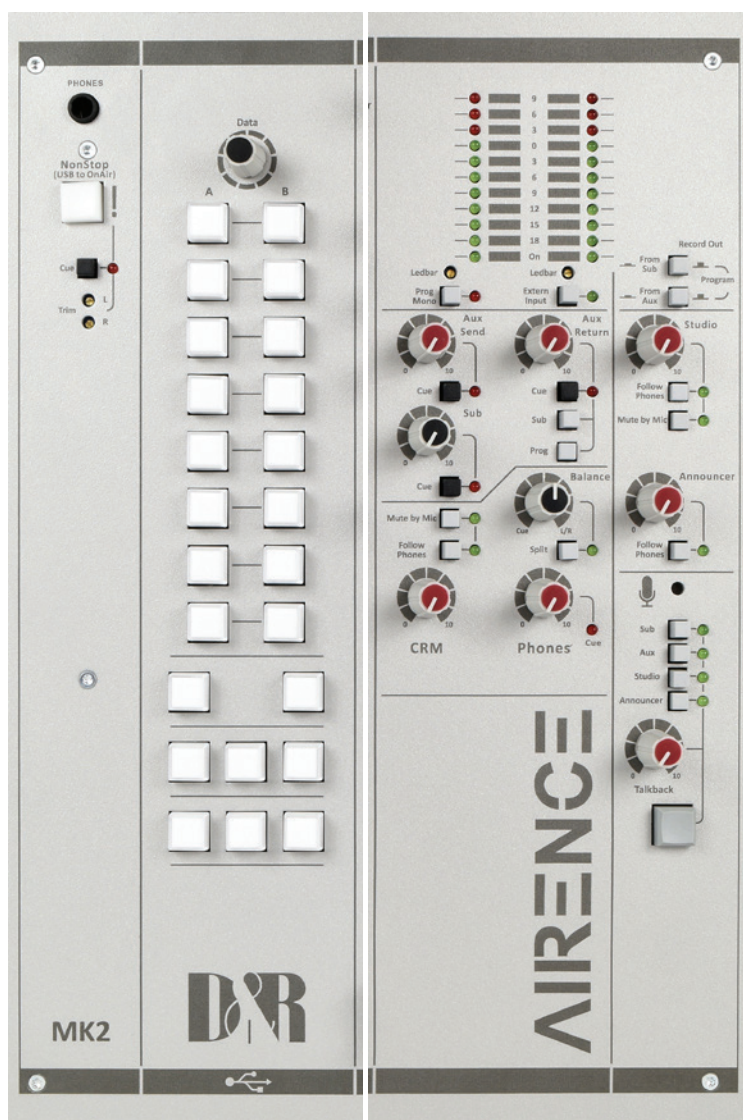

# The Extender & Software

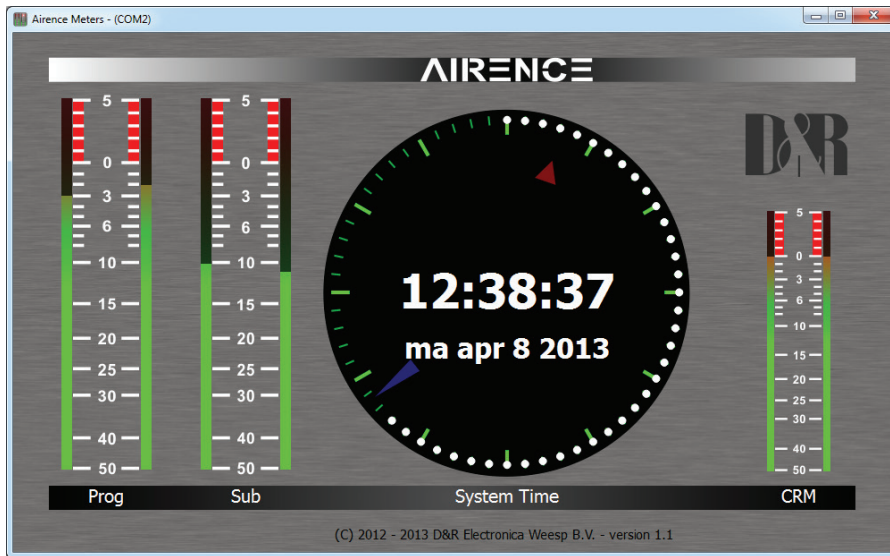

## AIRENCE EXTENDER UNIT

The AIRENCE-EXTender is a fully self functioning and self powered channel extender that can be connected to the main unit.

It holds 6 Triple inputs with balanced very low noise Mic inputs and 2 stereo line level inputs. Line level B can be converted into a Phono pre-amp by way of the optional RIAA pre-amp that can be ordered as an option.

It has a three band very musical EQ, Sub and PROG routing, a CUE / Communication buss and 100 mm faders with fader start. Of course this unit has MIC inserts for voice processors.

On the back of the AIRENCE-EXT unit is a 5 pole DC connector for the high efficiency switched mode power supply. A 15 pole Sub-D connector links the Extender to the main unit and eventually to a third 6 channel extender.

Also the AIRENCE Extender control surface can be easily mounted inside furniture as a drop through unit with rounded off corners to make a nice fit.

## SOFTWARE

The AIRENCE sends out control signals over USB, based on the HID protocol. This also means that the main output signals can be displayed on a TFT screen in a beautiful meter application. Both Program and Sub stereo signals are shown on a high resolution PPM. A smaller separate stereo meter on the right hand side of the meter application shows all signals heard through the CRM speakers. At the same time this software application shows you a professional looking Radio clock that is synchronized with your local PC.

## SUMMARY

We hope to have given you an idea of the huge potential of this new AIRENCE broadcast mixer and its Extender unit(s).

If you need more info than presented here in this brochure, visit our website page of the AIRENCE so you can download the manual for even more in depth info.

## SPECIFICATIONS

### INPUTS

Mic inp : bal, 2 kOhm, XLR ,48 volt Phantom.  
 Noise : - 128 dB (A-weighted). (That 1510)  
 Sensitivity : - 70dB min, OdB Max.  
 Insert : Jack unbal. send 600 Ohm -10dBv.  
 Aux Ret. : unbalanced 10kOhm -10dBv.  
 Line inputs: unbal., 10kOhm, Cinch.  
 Gain : range of 40dB.  
 Phono inp.: unbal. 47kOhm, 5 mV. (option)  
 USB : 4x Stereo in and 4x stereo out.  
 Extern in : - 10 dBV @10kOhm.  
 Aux ret. : - 10 dBV at 10kOhm stereo

### USB

Fully compliant with USB 2.0 play-back and record mode. 4x Stereo in and Main stereo or SUB signals out. 24 free assignable illuminated switches plus encoder based on the HID protocol.

### Telco|VoIP|Wireless Phone Channel option

RJ-11 connectors for phone line and dialler Mix Minus rejection @1kHz -40dB. VoIP via USB connector. WPC with an internal receiver and transmitter.

### OUTPUTS

Left/Right : + 6dBu bal. XLR.  
 Monitor/Aux : + 6dBu unbal. on Cinch.  
 Studio : + 6dBu, Jacks.  
 Tape outp : -10dBv.  
 Headphone : 32-600 Ohm, Jack.  
 Announcer : 32-600 Ohm, Jack.  
 USB out : PROGRAM /SUB/AUX.  
 Options : AES-3 Digital PRG outputs.  
 : Telco|VoIP|Bluetooth chan.

### EQUALIZER

High : + / -12 dB at 12kHz shelving.  
 Mid : + / -12dB at 1 kHz bell curve.  
 Low : + / -12dB at 60 Hz bell curve.

### OVERALL

Frequency response : 10 - 60.000Hz.  
 Distortion : < 0.01% max at 1 kHz.  
 Start switch : reed relay. (24volt/50mA)  
 Ledbars : 11 segment +  
 : Software meter app.

### CONTROL SOFTWARE

A software program is included in the delivery for programming the Control section. (Airence Virtual Keyboard Mapper)

### DIMENSIONS

**Main unit**  
 Left-Right(X) : 482mm  
 Front panel thickness: 2mm  
 Radius Corners : 20mm  
 Front-Back (Y) : 355mm (8HE).  
 Height : 101,50mm.  
 Weight : 9kg.

**Extender unit**  
 Left-Right (X) : 302mm  
 Front panel thickness: 2mm  
 Radius Corners : 20mm  
 Front-Back (Y) : 355mm (8HE).  
 Height : 101,50mm.  
 Weight : 7kg.

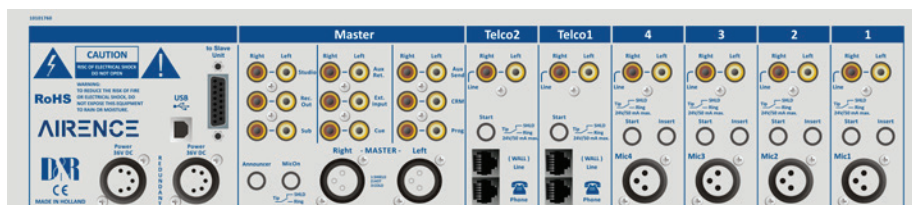

Back panel AIRENCE-main unit

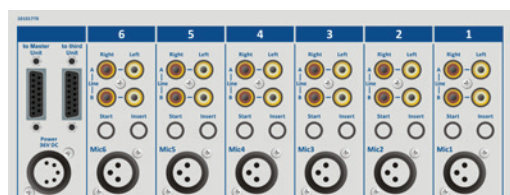

Back panel AIRENCE-Extender

# Signal Flow

## TRIPLE INPUT MODULE

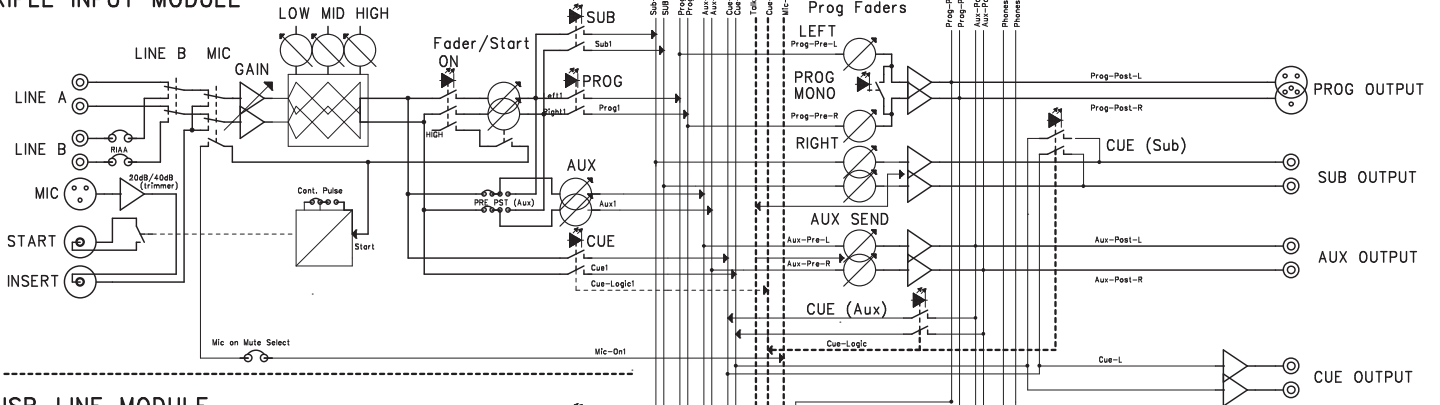

## USB-LINE MODULE

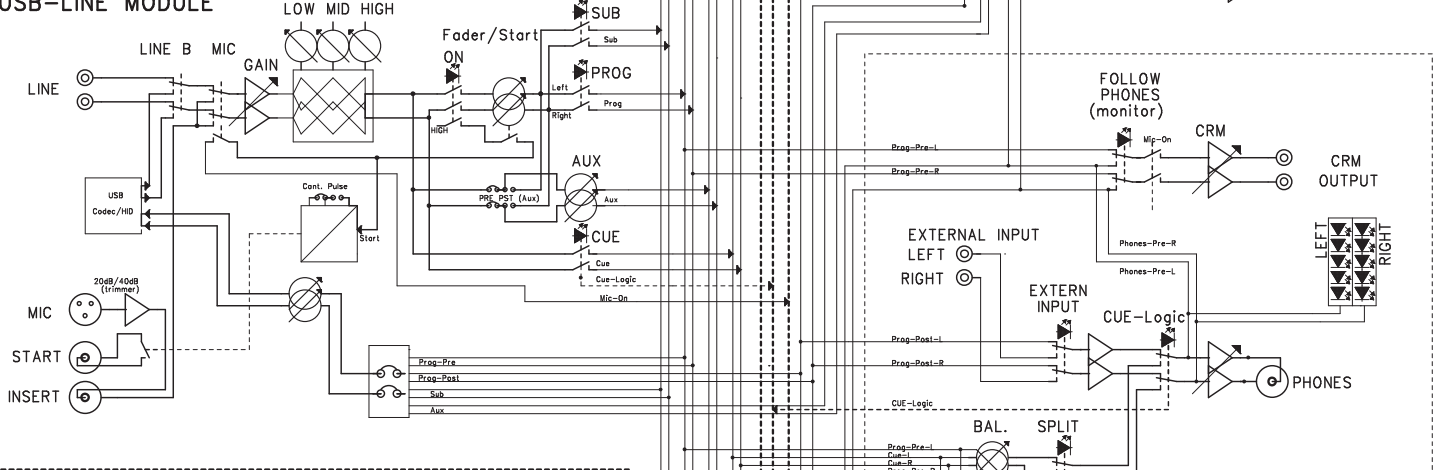

## TELCO-LINE MODULE

